

CFP 2/4/8 ZONE CONVENTIONAL FIRE ALARM CONTROL PANEL

user manual & log book

Approved Document No. DFU7001010 Rev 1



CONTENTS

Safety	3
Important information regarding the safe use of this fire alarm panel	
CFP Key Features	3
Lists the different features available on the CFP range of conventional fire alarm panels	
Fire Alarm Systems - An Overview	4
How fire alarm systems operate and a general overview of their key features	
User Responsibilities	5
General guidelines on what the user is expected to do	
Panel Layout/Accessing the Controls	6
A summary of the controls and indicators available on this fire alarm panel, including:	
Control level definition	
How to access the panel's secure user functions	
What the indicators mean	
Fire Conditions	8
How an alarm is indicated, and how to deal with it	
How to silence the alarm sounders	
How to manually activate the alarm sounders (i.e. to evacuate the building)	
How to reset a fire alarm condition	
Fault Conditions	9
The different types of fault that may occur, what they mean and how to deal with them	
Disablements	10
How to inhibit the functionality of certain parts of the fire alarm system	
Notes on Delays	12
Important information about delays, what they mean and what you should do about them	
System Set-Up Data Chart	13
Details of how the system has been set-up	
Fire Alarm Log Book	14
A place for you to record details of events such as fires, false alarms, call outs, etc.	
Certificate of Installation	19
Certificate of Commissioning	20

© Errors & Omissions Excepted. The manufacturer of this product operates a policy of continuous improvement and reserves the right to alter product specifications at its discretion and without prior notice. All of the instructions covered in this manual have been carefully checked prior to publication. However, no responsibility can be accepted by the manufacturer for any inaccuracies or for any misinterpretation of an instruction or guidance note.

SAFETY

The fire alarm panel is safe to operate provided it has been installed in compliance with the manufacturer's instructions and used in accordance with this user manual.



Do not operate the fire alarm panel with its enclosure open. There is no need to open the enclosure except to carry out commissioning, maintenance and remedial work. This work must only be carried out by competent service personnel who are fully conversant with the contents of the separate engineering manual for this product and have the necessary skills for maintaining this equipment.

If the enclosure is damaged in any way, expert advice should be sought regarding its repair.

Regular servicing of the fire alarm system is highly recommended, preferably on a continuous maintenance contract and by a competent organisation. A full-itemised report of the installation should be obtained at least annually.

CFP KEY FEATURES

The key features chart (below) illustrates different features available on the CFP range of fire panels.

Hint: The panel label will help you identify the CFP type.

This user manual details all the available features therefore, some sections of this manual may not be applicable to the model you are using.

CFP PANEL RANGE	Zone delay facility	Non-latching zones facility	Coincidence (double-knock) facility	Zone test facility	Fault diagnostic facilities	Ancillary connections for system expansion	Front panel code entry version available	Front panel keyswitch version available
CFP Economy Panel	✗	✗	✗	✓	✓	✗	✓	✓
CFP Standard Panel	✓	✓	✓	✓	✓	✓	✓	✓
CFP LPCB Approved Panel	✓	✗	✗	✓	✓	✓	✓	✗
CFP AlarmSense	✓	✓	✓	✓	✓	✓	✓	✓



This product has been manufactured in conformance with the requirements of all applicable EU Council Directives.

FIRE ALARM SYSTEMS – AN OVERVIEW

The primary purpose of a fire alarm system is to provide an early warning of a fire so that people and animals can be evacuated and action taken to stop the fire as soon as possible - all according to a predetermined plan.

Alarms may be raised automatically by smoke or heat detectors, or manually by a person operating a manual call point.

To ensure an alarm is dealt with in an orderly manner, it is important to know where the alarm is coming from. To aid this function, fire alarm systems are usually split into zones, each covering a different area of a building.

When an alarm has been raised, the fire alarm panel responds by indicating the zone in which the alarm has occurred and activating all relevant sounders, bells and other alarm outputs to provide a warning of the fire. Additional alarm outputs available on the CFP range of fire alarm panels (which may, or may not be used depending on the requirements of the site) are:

- **A Remote Output:** this output is activated when the panel is in alarm and is returned to normal when the alarm sounders are silenced. It may be used to signal an alarm condition to other parts of the fire alarm system. If used, its function will be declared on the System Set-up Data Chart (page 13) of this manual. This output may be disabled if required.
- **An Auxiliary Output:** this output is activated when the panel is in alarm and is returned to normal when the panel is reset. It may be used to signal an alarm condition to other parts of the fire alarm system. If used, its function will be declared on the System Set-up Data Chart (page 13) of this user manual. This output may be disabled if required.

The building's fire management plan should always be executed when the fire alarm panel goes into alarm. See User Responsibilities (page 5) for further details.

Fault monitoring

For obvious reasons, the reliability of the fire alarm system is paramount. To this end, the fire alarm panel continuously monitors all connections between detectors, manual call points and sounders and also checks its own power supply and back-up batteries for faults.

If a fault is detected anywhere on the system, the panel responds by illuminating one or more of the fault light(s) located on the panel front and sounding its internal fault buzzer. The panel's fault output is also activated, sending notification of the fault (if connected) to a remote manned monitoring centre or other electronic equipment, as required.

Delays

Certain zones on a fire alarm system can be prone to conditions that lead to frequent and unavoidable false alarms, a common example being a loading bay filled with vehicle smoke. In such areas it may be acceptable to delay the activation of the alarm sounders and other outputs to give a responsible person time to investigate the cause of the alarm. If the cause is found to be a true fire hazard, the delay can be overridden. In the event of a false alarm, the panel can be reset. Should the delay period expire without any user intervention, the alarm sounders will automatically sound to evacuate the premises. To ascertain if any delays have been programmed into the panel, refer to the System Set-Up Data Chart (page 13).

Disablements

In abnormal conditions, certain parts of the fire alarm system can be temporarily turned off (disabled) to suit prevailing conditions. For example, if there is a risk of a false alarm occurring in a zone, say from vehicle exhaust smoke in a loading bay, it is possible to disable that zone during the risk period, then enable it again afterwards. Another example is the disablement of outputs during a routine test or temporary fault.

Coincidence

The consequence of a false alarm on some fire alarm systems, particularly those connected to sprinkler or gas extinguishant systems, can be onerous. To help reduce the risk of a false alarm, certain zones on the system can be coupled together so that the alarm sounders and outputs only activate when there is a fire condition on **both** zones. The only way to tell if and how this feature has been utilised is to refer to the System Set-up Data Chart (page 13).

USER RESPONSIBILITIES

BS5839-1: 2002 is the British Standard code of practice for the design, installation, commissioning and maintenance of fire detection and fire alarm systems for buildings. Section 7 of the standard (User Responsibilities) states that a named responsible person should be appointed to supervise all matters pertaining to the fire alarm system {clause 47.2a}.

Highlighted below is a *summary* of the main functions of the responsible person is expected to carry out with regard to BS5839-1: 2002 only. It does not highlight any other responsibilities that may be required of the user or responsible person that is listed in documentation such as the Employers Guide to Fire Safety, the Fire Precautions (Workplace) regulations and/or any other legislation relevant to the premises. If in doubt, the fire authority can advise on the fire legislation that applies to any given building. For countries outside the UK, different user responsibilities may apply.

BS5839-1: 2002 states the responsible person should:

(The bracketed numbers {xx} identify the BS5839-1: 2002 clauses to which the summary refers).

- 1 Ensure the fire alarm panel is checked daily to confirm there are no faults on the system {47.2b}.
- 2 Ensure arrangements are in place for the test, maintenance and regular servicing of the system with regard to Section 6 of the standard {47.2c}.
Important: Clause 44 of BS5839-1: 2002 recommends weekly and monthly tests that should be carried out by the user/responsible person - please refer to the bottom of this section for further details.
- 3 Ensure the system log book is kept up to date by recording fire signals, fault signals, work on the system, etc, and make sure it is available for inspection at all times {47.2d/48}.
- 4 Ensure that all relevant occupants of the protected premises are instructed in the proper use of the system {47.2e}.
- 5 Take steps to limit the number of false alarms on the system {47f}.
- 6 Ensure the effectiveness of the system is not impaired by ensuring there is a space of at least 500mm in all directions around and below every fire detector and that all manual call points are unobstructed and easy to see {47g}.
- 7 Liaise with all relevant building engineers, decorators, etc., to ensure any changes to (or maintenance of), the building's fabric does not compromise the protection given by the fire alarm system, create faults or false alarms {47h}.
- 8 Ensure that any structural or occupancy changes planned for the building are done so with due and early consideration given to any changes that may be required to the fire system {47h}.
- 9 Ensure that a selection of spare parts are held as appropriate within the premises {47j}.

Routine weekly and monthly testing to be undertaken by the user/responsible person:

To meet the requirements of Clause 44 of BS5839-1:2002 we recommend the following tests are carried out at approximately the same time each week, during normal working hours:

Note: It is essential any alarm receiving centre is contacted before and after these tests to avoid unwanted alarms and to confirm the fire signal is correctly received.

- Carry out an Indicator lamp test to check all zone lights show and the beeper sounds.
- Operate a manual call point or smoke/heat detector to test the fire alarm.
- Check that the alarm sounders operate.
- Reset the system by pressing the Silence/Activate Sounders button and Control Panel Reset button.
- Verify that no manual call points or smoke/heat detectors are obstructed in any way.
- Test a different zone each week using a different call point or detector so all are tested in rotation.

Monthly attention: Ensure authorised service personnel verify the system's standby power supply (or supplies) are in good working order.

Quarterly and periodic inspection, testing, servicing and maintenance

It is the user's responsibility to ensure that an ongoing periodic plan is in place that meets Clause 45 (Inspection and Servicing) of BS5839-1:2002. The work required to meet this Clause must be carried out by a competent person with specialist knowledge of fire detection and alarm systems. The standard recognises this will normally be an outside specialist fire alarm servicing organisation.

Please note: the above summaries do not replace Sections 6 and 7 of BS5839-1: 2002 but are intended to help the user gain a greater understanding of his or her responsibilities. We strongly recommend the named responsible person familiarises themselves with the full standard, copies of which are available from your local reference library or can be purchased from the British Standards Institute, Customer Services Dept., 389 Chiswick High Road, London, W4 4AL. Tel: +44 (0)20 8996 9001. Web: www.bsi-global.com.

PANEL LAYOUT/ACCESSING THE CONTROLS

The fire alarm panel is available in two front panel versions; keyswitch and code entry (CFP model dependent - see page 3), allowing different methods for entering access level two. **Note:** Repeater Fault and Output Delays lights are not on the CFP Economy Panel.

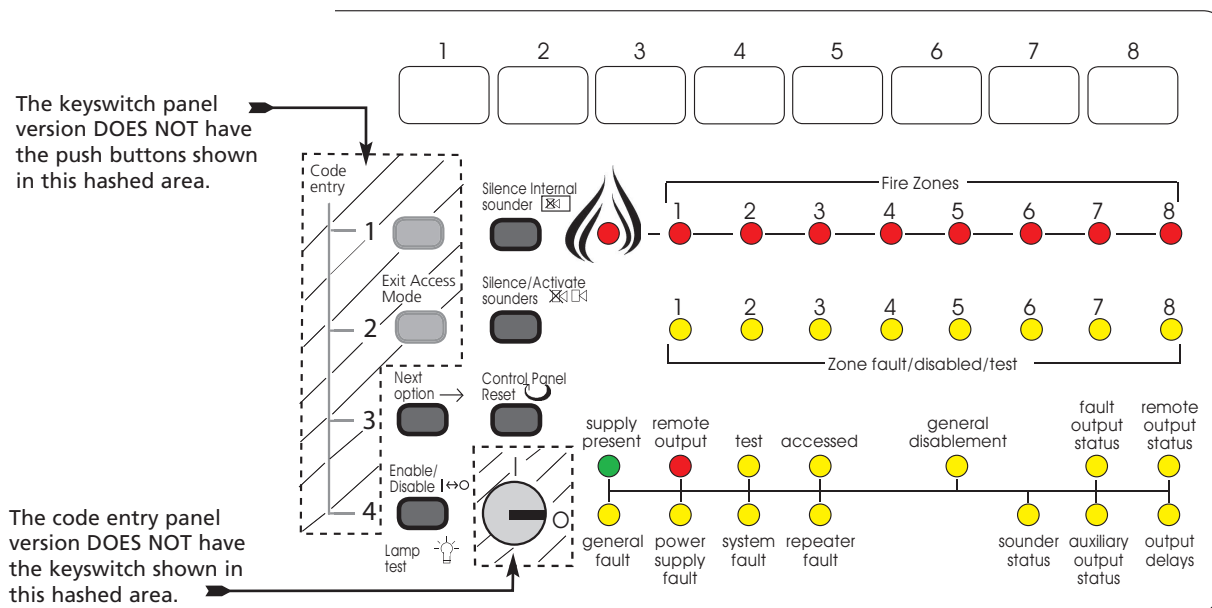

Two levels of control are available to user(s) of this fire alarm panel; General User and Authorised User.

1. General User Controls (access level one)

When the panel is in access level one, the indicator lights on the panel front give a comprehensive overview of the system's current status. Any fire and fault conditions are clearly displayed, disablements highlighted and the status of all outputs reported. For detailed descriptions of what each indicator means, see page 7.

The only functions that can be performed by the user when the panel is in access level one are:

- Muting the panel's internal sounder by pressing the Silence Internal Sounder button;
- Overriding any delays (CFP model dependent - see page 3) which may have been programmed into the panel by pressing the Silence/Activate Sounders button (only applicable when the panel is in alarm); or
- Putting the panel into access level two (the Authorised User state) - see below.

2. Authorised User Controls (access level two)

To avoid unauthorised changes to critical parts of the fire alarm system, controls such as silencing the sounders, resetting an alarm condition and setting disablements are only accessible via a secure method of entry which puts the panel into access level two.

To put the panel into access level two on the code entry version of the fire alarm panel:

Enter the code **2 1 4 3** using the code entry buttons on the panel front. During the code entry sequence, the panel's accessed light will pulse. If an incorrect sequence of numbers is entered after four button presses the accessed light will stop pulsing and you must enter the code again. When the correct code is entered, the accessed light will be lit steady to indicate that the controls are operative. To exit access level two, press the Exit Access Mode button.

To put the panel into access level two on the keyswitch version of the fire alarm panel:



Turn the key to the '1' position (**Note:** The key cannot be removed when in this position). When the key is in the '1' position, the accessed light will be lit steady to indicate that the controls are operative. To exit access level two, turn the key back to the 'O' position.

Details of how to use the Authorised User controls can be found on pages 8 to 11 of this user manual.

CFP 2/4/8 ZONE CONVENTIONAL FIRE ALARM PANEL

What the indicators mean

The table below summarises the various indicators available on the fire alarm panel and what they mean in their various states. The final column highlights the pages(s) you should turn to for further information.

INDICATOR	STATUS OF LIGHT	WHAT THIS MEANS	FURTHER READING
 (General Fire)	Flashing Red	The panel has detected a fire alarm condition, or the Silence/Activate Sounders button has been pressed to evacuate the building	Page 8 (Fire Conditions)
	Steady Red	There is a silenced fire alarm condition on the system	
Fire Zones 1 to 8 	Flashing Red	A fire alarm condition has been detected on the zones which are flashing	Page 8 (Fire Conditions)
	Steady Red	There is a silenced fire alarm condition on the zones which are lit steady	
Zone fault/disabled/test 1 to 8 	Flashing Yellow (in sync with the General Fault indicator)	Faulty wiring has been detected on the zones which are flashing	Page 9 (Fault Conditions)
	Flashing Yellow (in sync with the Test indicator)	The zones which are flashing are in test mode	
	Steady Yellow	The zones which are lit steady have been disabled	Page 10 (Disablements)
supply present	Steady Green	The panel is supplied with power	Page 4 (Overview)
remote output	Steady Red	The remote output has been activated	
test	Flashing Yellow	The panel is in test mode	
accessed	Flashing Yellow	The access code is in the process of being entered	Page 6 (Accessing the Controls)
	Steady Yellow	The panel is in access level two	
general disablement	Flashing Yellow	The panel is in the disablement selection state	Page 10 (Disablements)
	Steady Yellow	Part of the system has been manually disabled and/or one or more of the fire zones have a delay applied to them (CFP model dependent - see page 3)	Page 10 (Disablements) Page 12 (Notes on Delays)
fault output status	Flashing Yellow	A fault has been detected on the output's auxiliary 24V supply	Page 9 (Fault Conditions)
	Steady Yellow	The fault output has been disabled	Page 10 (Disablements)
remote output status	Flashing Yellow	A fault has been detected on the output's auxiliary 24V supply	Page 9 (Fault Conditions)
	Steady Yellow	The remote output has been disabled	Page 10 (Disablements)
general fault	Flashing Yellow	A fault has been detected on the system	Page 9 (Fault Conditions)
power supply fault	Flashing Yellow	The panel has detected a fault with its power supply, battery charger or back-up batteries	
system fault	Flashing Yellow	The panel has detected a microprocessor fault	
repeater fault (model dependent - see page 3)	Flashing Yellow	The panel has detected a wiring/communication fault on the repeater network	
sounder status	Flashing Yellow	Faulty wiring has been detected on the panel's sounder circuits	Page 10 (Disablements)
	Steady Yellow	The alarm sounders have been disabled	
auxiliary output status	Flashing Yellow	A fault has been detected on the output's auxiliary 24V supply	Page 9 (Fault Conditions)
	Steady Yellow	The panel's auxiliary output has been disabled	Page 10 (Disablements)
output delays (CFP model dependent - see page 3)	Steady Yellow	Delays have been programmed into the panel	Page 12 (Notes on Delays)
	Flashing Yellow	A delay is running	

Testing the indicator lights

To test the panel's indicator lights are working correctly, press the Lamp Test button when the panel is in the accessed state. The panel's internal beeper also sounds when pressing this button to show it is working correctly.

FIRE CONDITIONS

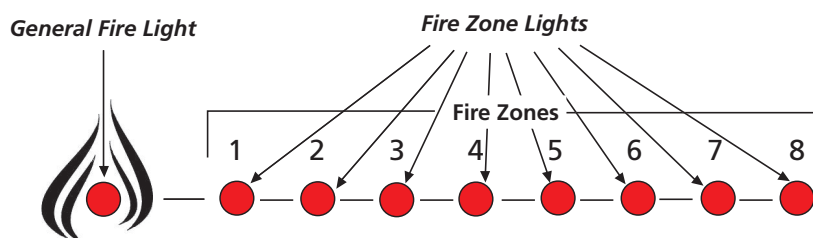

When the fire alarm panel receives an alarm trigger from a detector or manual call point located in a zone that is not already in a fire state, it will:

- Flash the general fire and appropriate fire zone light(s) on the panel front.
- Activate its internal sounder.
- Start the alarm sounders and outputs including, if enabled, the remote and auxiliary outputs (provided there are no delays applicable to the zone which is in alarm - CFP model dependent, see page 3).

At this point the building's fire management plan should be executed!



Important Note: Zones which have been disabled cannot be triggered into an alarm condition (see page 10 for further information on disablements).

Silencing the alarm sounders

- The alarm sounders may be silenced by putting the panel into access level two and pressing the Silence/Activate Sounders button.

The alarm sounders and the panel's internal sounder will stop sounding and the light(s) for the zone(s) in alarm and the general fire light will be lit steady. The remote output will turn off, but the auxiliary output will stay on.

New zone in alarm

Should a new zone be triggered into alarm whilst the alarm sounders are silenced, the panel will:

- Automatically reactivate the alarm sounders.
- Flash the general fire light and appropriate fire zone light(s) for any new zone(s) in alarm.
- Keep the light(s) for the previous zone(s) in fire lit steady.

Manually activating the alarm sounders (i.e. to evacuate the building)

- Momentarily pressing the Silence/Activate Sounders button when the panel is in access level two (see page 6) will cause the alarm sounders to sound. **Note:** The panel's remote and auxiliary fire outputs will not be triggered when the building is manually evacuated in this way.

Pressing the Silence/Activate Sounders button again will silence the alarm sounders.

Note: If the sounders have been disabled, pressing the Silence/Activate Sounders button will have no effect.

Resetting the panel

- After the cause of the alarm has been investigated and cleared and the alarm sounders have been silenced, the panel can be reset by pressing the Control Panel Reset button.

The panel will give a double beep to indicate the reset process has started and, after a few seconds, the zone fire and general fire lights will go out to indicate the process is complete. If there are still alarm triggers on any zone the panel will go back into alarm as before.

FAULT CONDITIONS

When a fault occurs on a critical part of the fire alarm system, the panel responds by activating its internal sounder and illuminating the general fault light and any other fault light(s) relating to the fault. The panel's fault output will also activate (provided it hasn't been disabled). The type of faults typically indicated at the fire alarm panel are described below:

General Fault

Flashes when there is a fault on any part of the fire alarm system. It is always lit in sync. with at least one other fault light which displays precise information on the type of fault detected.

Zone Faults

The relevant zone fault light flashes when there is a wiring problem on a zone or a detector has been removed from its base. **Note:** Any alarms raised on the faulty zone(s) may not be recognised by the fire alarm panel until the fault condition has been cleared.

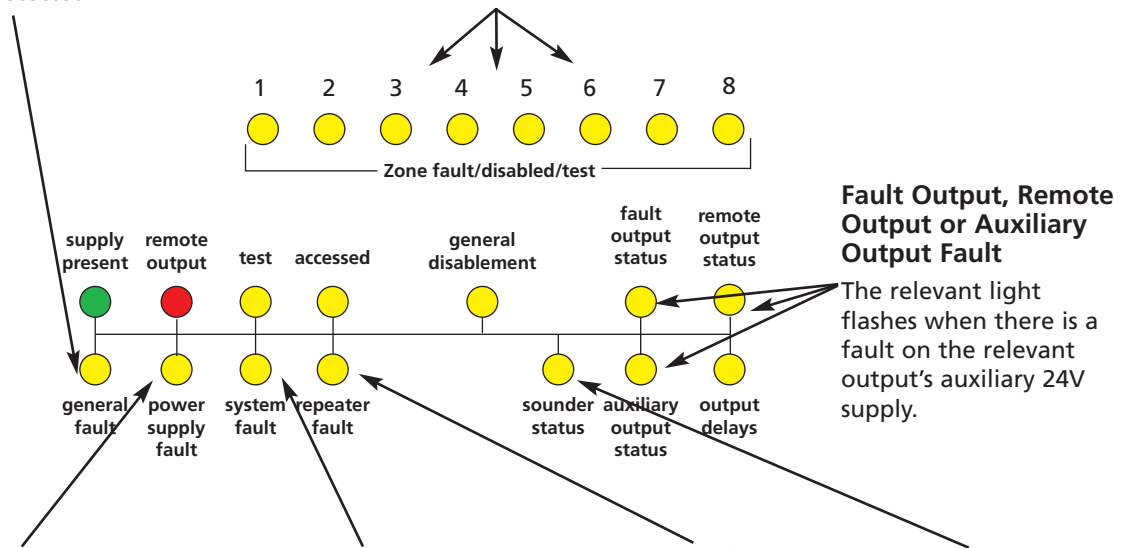

Power Supply Fault

Flashes when the mains supply has failed, or the standby batteries or its charger are faulty. If the mains supply fails, the panel will only operate for the standby period determined by the size of the batteries fitted. If the batteries or charger fail at the same time as the mains, the panel will not operate.

System Fault

Flashes when the panel's microprocessor has reset, typically after excessive electrical interference, or if the contents of its memory have been corrupted. This fault can only be cleared by pressing the Control Panel Reset button. If the fault re-occurs within two minutes, this indicates corrupt memory and expert advice should be sought.

Repeater Fault

(CFP model dependent - see page 3) Flashes when the connection between a repeater fire alarm panel (if fitted) and the master fire alarm panel fails. Depending on where the fault has occurred, some or all of the repeaters may not operate.

Sounder Status

Flashes when there is a wiring fault on the sounder circuits. Depending on where the fault has occurred, one or all of the alarm sounders may not operate.

Fault Output, Remote Output or Auxiliary Output Fault

The relevant light flashes when there is a fault on the relevant output's auxiliary 24V supply.

In the event of a fault condition:

- Mute the panel's internal sounder by pressing the Silence Internal Sounder button (the panel does not have to be in access level two to do this).
- Record the fault(s) in the Fire Alarm Log Book (page 14) and take appropriate action to correct it/them. See User Responsibilities (page 5).

When a fault has been rectified the indicator light for that fault is automatically turned off. If all faults are cleared, the general fault light will go out, and the panel's internal sounder will be silent (if not already muted). If the fire alarm panel is reset any existing fault(s) will reappear as before and the silencing process will have to be repeated.

DISABLEMENTS

Certain fire alarm panel functions can be temporarily disabled (i.e. switched off) to suit certain conditions. For example, if there is a risk of a false alarm in a zone, e.g. from vehicle exhaust smoke in a loading bay, it is possible for the user to disable that zone during the risk period and enable it again afterwards. Another example is the disablement of outputs during a routine test or temporary fault.

The following is a list of options that may be disabled by a level two user at the fire alarm panel and the effect their disablement will have on how the system works:

OPTION	EFFECT ON SYSTEM WHEN DISABLED
Zone 1	Alarms and faults on zone 1 will not be processed
Zone 2	Alarms and faults on zone 2 will not be processed
Zone 3 (only available if fitted)	Alarms and faults on zone 3 will not be processed
Zone 4 (only available if fitted)	Alarms and faults on zone 4 will not be processed
Zone 5 (only available if fitted)	Alarms and faults on zone 5 will not be processed
Zone 6 (only available if fitted)	Alarms and faults on zone 6 will not be processed
Zone 7 (only available if fitted)	Alarms and faults on zone 7 will not be processed
Zone 8 (only available if fitted)	Alarms and faults on zone 8 will not be processed
Fault output	Faults will not be transmitted to any other equipment (if fitted)
Remote output	Alarms will not be transmitted to remote equipment (if fitted)
Sounders	The alarm sounders will not operate in a fire condition
Auxiliary output	Alarms will not be transmitted to local fire fighting equipment (if fitted)
Output delays (only available if delays have been programmed into the panel by an engineer)	See 'Notes on Delays' (page 12) for information regarding delays before attempting to alter this function. CFP model dependent - see page 3.

To disable or enable any of the above options:

1. Put the fire alarm panel into access level two (see **Authorised User Controls** - page 6).
2. Start the selection process by pressing and holding the **Next Option** button for 3 seconds.

The general disablement light will flash and the fault light relating to the first option in the above table will flash to show it is selected.

If the light flashes at a slower rate than the general disablement light, the option is enabled.

If the light flashes at the same rate as the general disablement light, the option is disabled.

3. If necessary, press the **Enable/Disable** button to toggle the selected option between disabled and enabled.
4. To confirm your choice, press the **Next Option** button.

This will move the selection process on to the next available option in the above table and the fault light relating to this new option will flash to show it is selected. The previous option's fault light will now be lit steady to confirm it is disabled or switched off to confirm it is enabled.

5. Repeat steps 3 & 4 for every available option until the selection process is complete.

The disablement/enabling process is complete when all available options have been selected in turn and the **Next Option** button is pressed for the last time. At this point all disabled options will be lit steady and all enabled options will have their lights switched off.

Note: The selection process can be exited at any time by pressing the **Exit Access Mode** button (code entry version), or turning the keyswitch to 'O' position (keyswitch version). The only changes that will be saved will be those made prior to the last press of the **Next Option** button.

To avoid confusion, during the selection process any light in the table of options that was showing a fault condition will have the fault indication turned off. After the selection process is complete, fault indication will be restored unless that option was disabled during the selection process.

Notes about disablements

- (a) The option of disabling or enabling zones 3 & 4 and zones 5, 6, 7 & 8 is only available if these zones are fitted. If they are not fitted, the selection process will skip to the next available option.
- (b) The option of disabling or enabling output delays is only available if delays have been programmed into the fire alarm panel by the installation engineer. If a delay has been programmed into the panel the output delays light will be lit when the panel is in the normal (i.e. non-accessed) state. **Important:** Please refer to the 'Notes on Delays' (page 12) before proceeding to make any changes to the way the delays function operates.

Diagram to show the disablement/enablement selection sequence

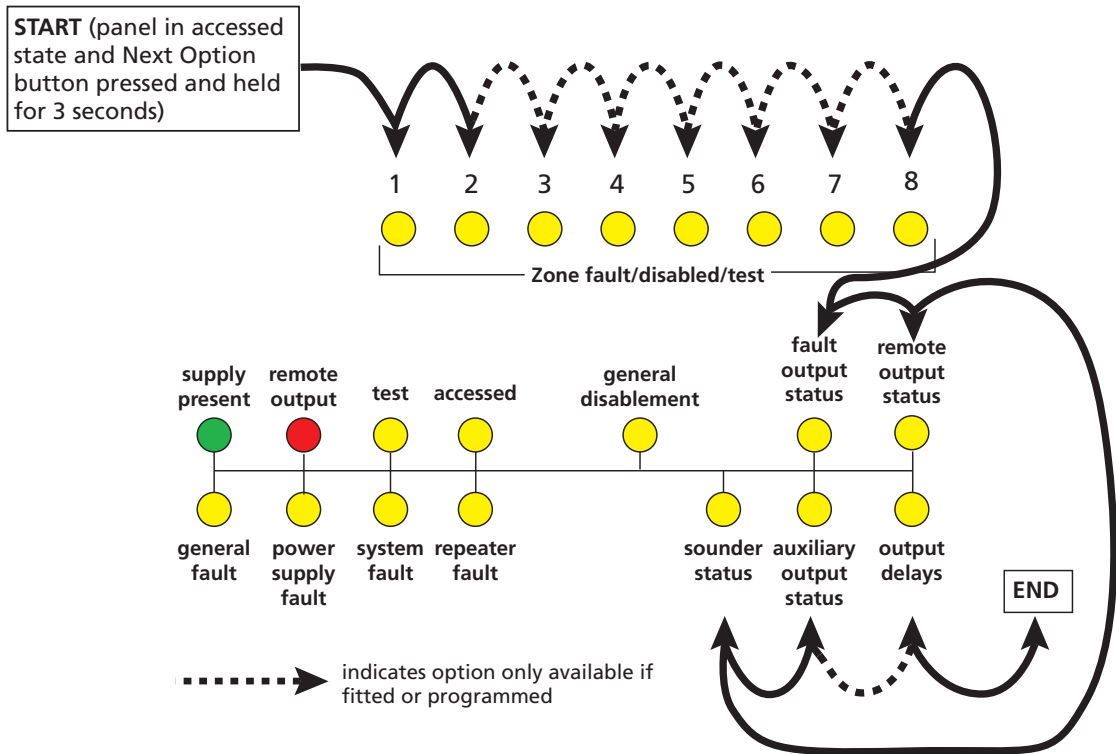

NOTES ON DELAYS

What is a delay?

A delay can be programmed into the fire alarm panel to postpone the activation of the alarm sounders and other outputs for a predetermined length of time. The delay period gives a responsible person time to investigate the cause of an alarm, usually in areas which are prone to false alarm (such as vehicle exhaust smoke in a loading bay) before the building is evacuated. If the cause of the alarm is found to be a true fire hazard, the delay can be overridden and the alarm sounders activated immediately. Alternatively, in the case of a false alarm, the panel can be reset.

Delay options

One, some or all of the zones on the fire alarm panel can have a delay applied to them to suit the requirements of the site. The same delay period applies to all delayed zones and is adjustable to a maximum of 10 minutes. The programming of delays must only be carried out by competent service personnel who are advised to record all relevant delay data on the System Set-Up Data Chart (page 13) of this user manual. Delays should only be used with the prior knowledge and consent of all relevant authorities, i.e. fire officer, building control, etc.

Delay indication

If delays have been programmed into the panel the output delays light and the general disablement light will be lit steady. This means the immediate turning on of the alarm sounders and other outputs on one or more zones has been disabled. The only way to ascertain which zones have been programmed with a delay is to refer to the System Set-Up Data Chart (page 13)

What happens when there is a fire alarm condition on a delayed zone?

Should an alarm occur on a delayed zone, the panel will:

- Flash its general fire and appropriate fire zone light(s)
- Sound its internal sounder
- Start the delay countdown sequence
- Indicate a delay is running by flashing its output delays light

How to override a delay in the event of a true fire alarm condition

- If, on investigation, the cause of the alarm on the delayed zone is found to be a true fire hazard, pressing the Silence/Activate Sounders button at any time will override the delay and activate the alarm sounders and outputs with immediate effect.

How to reset the system in the event of a false alarm

- If, on investigation, the cause of the alarm is found to be false, put the panel into access level two (see Authorised User Controls - page 6) and press the Control Panel Reset button.

How to turn the delays function on or off

Any delays that have been programmed into the panel can be turned on or off by putting the panel into access level two and following the disablement/enablement selection process as described on pages 10 and 11.

Selecting the Output Delays option and then pressing the Enable/Disable button so that the output delays light flashes in synchronisation with the general disablement light shows that the delays are on.

Pressing the Enable/Disable button again will make the output delays light flash slower than the general disablement light, showing that the delays are off.

Having chosen the desired setting, pressing the Next Option button will exit the disablement/enablement selection process. The output delays light will now be lit steady with the general disablement light, showing that delays are on, or the output delays light will be off, showing that delays are off.

SYSTEM SET-UP DATA CHART

Important: This page should be carefully completed by an authorised engineer prior to system hand-over.

FIRE ZONE INFORMATION			
ZONE NUMBER	ZONE DESCRIPTION A concise explanation of the rooms and areas contained in each zone	DELAY APPLIED?	COINCIDENCE (*) <i>(tick if selected)</i>
1		Yes/No	<input type="checkbox"/>
2		Yes/No	<input type="checkbox"/>
3		Yes/No	<input type="checkbox"/>
4		Yes/No	<input type="checkbox"/>
5		Yes/No	<input type="checkbox"/>
6		Yes/No	<input type="checkbox"/>
7		Yes/No	<input type="checkbox"/>
8		Yes/No	<input type="checkbox"/>

LENGTH OF DELAY (1 TO 10 MINUTES) IF APPLICABLE	
---	--

OUTPUT ROUTING INFORMATION		
TYPE OF OUTPUT	CONNECTED?	WHAT HAPPENS WHEN ACTIVATED?
REMOTE OUTPUT	Yes/No	
AUXILIARY OUTPUT	Yes/No	
FAULT OUTPUT	Yes/No	
RESET OUTPUT	Yes/No	

ADDITIONAL INFORMATION
Any additional Information the user needs to know should be entered in this box including repeater location, the routing of any additional outputs, details of any inputs utilised, etc.

THE INFORMATION ABOVE WAS COMPLETED BY (name) _____

OF (company) _____ ON (date) _____

(*) NOTES ON COINCIDENCE: The following applies to all pairs of zones which are set up for coincidence. There must be alarms on both zones (i.e. zone 1 and zone 2) before the alarm sounders and outputs turn on. If only one of the zones (i.e. zone 1) goes into alarm, the panel indicates the alarm by illuminating the relevant indicator on the panel front and sounding its internal sounder, thus prompting the user to investigate. If found to be false, the alarm can be reset or, if found to be a true fire condition, the sounders can be manually activated by pressing the Silence/Activate Sounders button - as detailed on page 8.

FIRE ALARM LOG BOOK

It is recommended that this log book be maintained by a responsible person, who should ensure that every entry is properly recorded. In the UK, this is necessary to satisfy the recommendations of BS5839-1: 2002, compliance with which may be a requirement of legislation. If your premises are certificated under the Fire Precautions Act 1971, failure to keep a suitable log book may be a breach of the requirements of the certificate, which is a criminal offence. In order to satisfy the requirements of BS5839-1: 2002 the following must be recorded:

- The name of the responsible person;
- Brief details of the maintenance arrangements;
- Dates and times of all tests, including fire drills;
- Dates and times of all fires to which the system responds;
- Dates and times of all false alarms;
- Causes, circumstances surrounding, and category of false alarms (if known);
- The identity of any manual call point or fire detector that triggers any of the above fire alarm signals (if known);
- Dates, times and type of all faults and defects.
- Dates and times of all maintenance (e.g service visit or non-routine attention).

USER:

SITE ADDRESS:

RESPONSIBLE PERSON(S) ON SITE:

THE SYSTEM WAS DESIGNED BY:

THE SYSTEM WAS INSTALLED BY:

THE SYSTEM WAS COMMISSIONED BY:

THE SYSTEM WAS ACCEPTED BY:

VERIFICATION WAS UNDERTAKEN BY:

FOR SERVICE (DETAILS OF WHO YOU SHOULD CONTACT IF MAINTENANCE IS REQUIRED)

THE SYSTEM IS MAINTAINED UNDER CONTRACT BY:

Company: _____

Address: _____

Contact No: _____ Expiry Date: _____

NORMAL HOURS (MON-FRI) TEL: _____

OUTSIDE NORMAL HOURS TEL: _____

MANNED CENTRE TEL: _____

MANNED CENTRE CODE: _____

THE NORMAL MAXIMUM ATTENDANCE TIME FOR A MAINTENANCE TECHNICIAN IS: _____

EXPENDABLE COMPONENT REPLACEMENT PERIODS (LIST):

BS5839-1:2002 recommends that certificates be issued for all aspects of the fire alarm system including design, installation, commissioning, acceptance, verification (optional) and maintenance. Therefore, before this user manual is handed over, the following installation certificate and commissioning certificate (overleaf) should be completed as appropriate by the relevant installation/commissioning engineer(s). Please ensure that the System Set-Up Data Chart (page 13) and the relevant parts of the Fire Alarm Log Book (page 14) are also completed as appropriate. For countries outside the UK, different certification requirements may apply.

Certificate of INSTALLATION for the fire alarm system at:

Address: _____

I/we being the competent person(s) responsible (as indicated by my/our signatures below) for the installation of the fire alarm system, particulars of which are set out below, CERTIFY that the said installation for which I/we have been responsible complies to the best of my/our knowledge and belief with the specification described below and with the recommendations of Section 4 of BS5839-1: 2002, except for the variations, if any, stated in this certificate.

Name (in block letters): _____
Position (in block letters): _____
Signature: _____
Date: _____
For and on behalf of: _____
Address & postcode: _____

The extent of the liability of the signatory is limited to the system described below.

Extent of installation work covered by this certificate:

Specification against which the system was installed:

Variations from the specification and/or Section 4 of BS5839-1:2002 (see BS5839-1:2002, Clause 7):

Wiring has been tested in accordance with the recommendations of Clause 38 of BS5839-1: 2002.
Test results have been recorded and provided to: _____

Unless supplied by others, the "as fitted" drawings have been supplied to the person responsible for commissioning the system (see Clause 36.2m) of BS5839-1: 2002: _____

BS5839-1:2002 recommends that certificates be issued for all aspects of the fire alarm system including design, installation, commissioning, acceptance, verification (optional) and maintenance. Therefore, before this user manual is handed over, the following commissioning certificate and the installation certificate (overleaf) should be completed as appropriate by the relevant installation/commissioning engineer(s). Please ensure that the System Set-Up Data Chart (page 13) and the relevant parts of the Fire Alarm Log Book (page 14) are also completed as appropriate. For countries outside the UK, different certification requirements may apply.

Certificate of COMMISSIONING for the fire alarm system at:

Address: _____

I/we being the competent person(s) responsible (as indicated by my/our signatures below) for the commissioning of the fire alarm system, particulars of which are set out below, CERTIFY that the said work for which I/we have been responsible complies to the best of my/our knowledge and belief with the specification described below and with the recommendations of Clause 39 of BS5839-1: 2002, except for the variations, if any, stated in this certificate.

Name (in block letters): _____
Position (in block letters): _____
Signature: _____
Date: _____
For and on behalf of: _____
Address & postcode: _____

The extent of the liability of the signatory is limited to the system described below.

Extent of system covered by this certificate:

Variations from the recommendations of Clause 39 of BS5839-1:2002 (see BS5839-1:2002, Clause 7):

- All equipment operates correctly
- Installation work is, as far as can be reasonably ascertained, of an acceptable standard.
- The entire system has been inspected and tested in accordance with the recommendations of 39.2c of BS5839-1:2002.
- The system performs as required by the specification prepared by: _____
a copy of which I/we have been given.
- Taking into account the guidance contained in Section 3 of BS 5839-1:2002, I/we have not identified any obvious potential for an unacceptable rate of false alarms.
- The documentation described in Clause 40 of BS5839-1:2002 has been provided to the user.

The following work should be completed before/after (delete as applicable) the system becomes operational:

The following potential cause(s) of false alarms should be considered at the time of the next service visit:

Before the system becomes operational, it should be soak tested in accordance with the recommendations of 35.2.6 of BS5839-1:2002 for a period of: _____ (enter a period of either one week, such period as required by the specification, or such period as recommended by the signatory of this certificate, whichever is the greatest, or delete if not applicable).